

GasAlertMicro 5

O₂, CO, H₂S, PH₃, SO₂, Cl₂, NH₃, NO₂, HCN, ClO₂, O₃, VOC, and Combustibles

1, 2, 3, 4, and 5 Gas Detectors

User Manual

"INNOVATORS IN GAS DETECTION"

BW
Technologies

Limited Warranty & Limitation of Liability

BW Technologies LP (BW) warrants this product to be free from defects in material and workmanship under normal use and service for a period of two years, beginning on the date of shipment to the buyer. This warranty extends only to the sale of new and unused products to the original buyer. BW's warranty obligation is limited, at BW's option, to refund of the purchase price, repair, or replacement of a defective product that is returned to a BW authorized service center within the warranty period. In no event shall BW's liability hereunder exceed the purchase price actually paid by the buyer for the Product.

This warranty does not include:

- a) fuses, disposable batteries or the routine replacement of parts due to the normal wear and tear of the product arising from use;
- b) any product which in BW's opinion, has been misused, altered, neglected or damaged by accident or abnormal conditions of operation, handling or use;
- c) any damage or defects attributable to repair of the product by any person other than an authorized dealer, or the installation of unapproved parts on the product; or

The obligations set forth in this warranty are conditional on:

- a) proper storage, installation, calibration, use, maintenance and compliance with the product manual instructions and any other applicable recommendations of BW;
- b) the buyer promptly notifying BW of any defect and, if required, promptly making the product available for correction. No goods shall be returned to BW until receipt by the buyer of shipping instructions from BW; and
- c) the right of BW to require that the buyer provide proof of purchase such as the original invoice, bill of sale or packing slip to establish that the product is within the warranty period.

THE BUYER AGREES THAT THIS WARRANTY IS THE BUYER'S SOLE AND EXCLUSIVE REMEDY AND IS IN LIEU OF ALL OTHER WARRANTIES, EXPRESS OR IMPLIED, INCLUDING BUT NOT LIMITED TO ANY IMPLIED WARRANTY OF MERCHANTABILITY OR FITNESS FOR A PARTICULAR PURPOSE. BW SHALL NOT BE LIABLE FOR ANY SPECIAL, INDIRECT, INCIDENTAL OR CONSEQUENTIAL DAMAGES OR LOSSES, INCLUDING LOSS OF DATA, WHETHER ARISING FROM BREACH OF WARRANTY OR BASED ON CONTRACT, TORT OR RELIANCE OR ANY OTHER THEORY.

Since some countries or states do not allow limitation of the term of an implied warranty, or exclusion or limitation of incidental or consequential damages, the limitations and exclusions of this warranty may not apply to every buyer. If any provision of this warranty is held invalid or unenforceable by a court of competent jurisdiction, such holding will not affect the validity or enforceability of any other provision.

BW Technologies LP
2840 – 2nd Ave. SE
Calgary, AB
Canada T2A 7X9

BW America
3279 West Pioneer Parkway
Arlington, TX
USA 76013

BW Europe
101 Heyford Park,
Upper Heyford, Oxfordshire
United Kingdom OX25 5HA

Table of Contents

| Title | Page |
|--------------------------------------|------|
| Introduction..... | 1 |
| Contacting BW Technologies..... | 2 |
| Safety Information - Read First..... | 2 |
| Getting Started..... | 6 |
| Activating the Detector..... | 10 |
| Self-Test..... | 10 |
| Self-Test Pass..... | 16 |
| Self-Test Fail..... | 16 |
| Battery Test..... | 16 |
| Datalogger Operation..... | 16 |
| Deactivating the Detector..... | 17 |
| User Options Menu..... | 17 |
| Exit User Options Menu..... | 18 |
| Options Menu..... | 19 |
| Sensor Configuration..... | 21 |
| Logger Option..... | 25 |
| Clock Option..... | 26 |
| Language Selection..... | 26 |
| Tech Mode..... | 27 |
| Alarms..... | 29 |
| Gas Exposures Computed..... | 32 |
| Viewing Gas Exposures..... | 32 |
| Clearing Gas Exposures..... | 32 |
| Gas Alarm Setpoints..... | 33 |
| Viewing the Alarm Setpoints..... | 33 |
| Stopping a Gas Alarm..... | 34 |

| | |
|--|----|
| Sensor Alarm | 34 |
| Pump Alarm | 34 |
| Low Battery Alarm | 34 |
| Automatic Shutdown Alarm | 35 |
| Calibration and Setting Alarm Setpoints | 35 |
| Guidelines | 35 |
| Diagnostics Protection | 36 |
| Applying Gas to the Sensors | 37 |
| Calibration Procedure | 37 |
| Datalogger | 44 |
| Datalog | 44 |
| MultiMediaCard Compatibility | 44 |
| MultiMediaCard Troubleshooting | 44 |
| Recovering Data Files | 44 |
| Importing the Data File Into Compatible Desktop Applications | 46 |
| Determining Application Compatibility | 46 |
| Maintenance | 48 |
| Replacing the Batteries | 48 |
| Replacing a Sensor or Sensor Filter | 49 |
| Photoionization Detector (PID) | 51 |
| Installing the MMC/SD Card | 53 |
| Troubleshooting | 54 |
| Replacement Parts and Accessories | 58 |
| Specifications | 60 |

List of Tables

| Table | Title | Page |
|--------------|--|-------------|
| Table 1. | Gases Monitored..... | 1 |
| Table 2. | International Symbols | 5 |
| Table 3. | GasAlertMicro 5 Detector..... | 7 |
| Table 4. | Display Elements | 8 |
| Table 5. | Pushbuttons | 9 |
| Table 6. | Alarms | 29 |
| Table 7. | Computed Gas Exposures..... | 32 |
| Table 8. | Gas Alarm Setpoints | 33 |
| Table 9. | Sample Factory Alarm Setpoints | 33 |
| Table 10. | Applying Gas to the Sensors | 37 |
| Table 11: | Datalogger Status Codes..... | 46 |
| Table 12. | Replacing the Batteries..... | 49 |
| Table 13. | Replacing a Sensor or Sensor Filter..... | 50 |
| Table 14. | Parts of the PID sensor..... | 51 |
| Table 15. | Installing the MMC/SD Card | 53 |
| Table 16. | Troubleshooting Tips | 54 |
| Table 17. | Replacement Parts and Accessories..... | 58 |

List of Figures

| Figure Title | Page |
|---|-------------|
| Figure 1. GasAlertMicro 5 Detector | 7 |
| Figure 2. Display Elements | 8 |
| Figure 3. Applying Gas to the Sensors | 37 |
| Figure 4. Replacing the Batteries..... | 49 |
| Figure 5. Replacing a Sensor or Sensor Filter | 50 |
| Figure 6. Parts of the PID..... | 51 |
| Figure 7. Installing the MMC/SD | 53 |

GasAlertMicro 5

User Manual

CAUTION: FOR SAFETY REASONS, THIS EQUIPMENT MUST BE OPERATED AND SERVICED BY QUALIFIED PERSONNEL ONLY. READ AND UNDERSTAND INSTRUCTION MANUAL COMPLETELY BEFORE OPERATING OR SERVICING.

GasAlertMicro 5 Multi-Gas Detector

Standard instrument is equipped with integral concussion-proof boot and internal vibrator alarm.

GasAlertMicro 5 with User Downloadable Datalogger

Provides full-time continuous datalogging while the instrument is operating. Data is saved on a convenient MultiMediaCard (MMC) and can be removed and downloaded by the user. Data is imported into standard office software (Microsoft® Excel, Access etc.). Wraparound memory ensures the most recent data is always saved. Datalogging units include the Fleet Manager software.

GasAlertMicro 5

Introduction

Warning

To ensure your personal safety, read “Safety Information” before you use the detector.

The GasAlertMicro 5 gas detector (“the detector”) warns of hazardous gas at levels above user-selectable alarm setpoints. This product is a gas detector, not a measurement device.

The detector is a personal safety device. It is your responsibility to respond properly to the alarm.

Table 1 lists the gases monitored.

Table 1. Gases Monitored

| Gas Detected | Unit of Measure |
|--------------------------|-----------------------|
| Oxygen (O ₂) | percent by volume (%) |

| Gas Detected | Unit of Measure |
|--|--|
| Combustible gases Field selectable for: | a) percent of lower explosive limit (% LEL) b) percent by volume methane 0-5.0% v/v |
| Carbon monoxide (CO) | parts per million (ppm) |
| Hydrogen sulfide (H ₂ S) | parts per million (ppm) |
| Phosphine (PH ₃) | parts per million (ppm) |
| Sulfur dioxide (SO ₂) | parts per million (ppm) |
| Chlorine (Cl ₂) | parts per million (ppm) |
| Ammonia (NH ₃) | parts per million (ppm) |
| Nitrogen dioxide (NO ₂) | parts per million (ppm) |
| Hydrogen cyanide (HCN) | parts per million (ppm) |
| Chlorine dioxide (ClO ₂) | parts per million (ppm) |
| Ozone (O ₃) | parts per million (ppm) |
| Volatile organic compounds (VOC) | parts per million (ppm) |

Contacting BW Technologies

To contact BW Technologies, call:

USA: 1-888-749-8878

Canada: 1-800-663-4164

Europe: +44 (0) 1869 233004

Other countries: +1-403-248-9226

Address correspondence to:

BW Technologies LP

2840 – 2 Avenue S.E.

Calgary, AB T2A 7X9

CANADA

Email us at: info@bwt.net

Or visit us on the World Wide Web: www.gasmonitors.com

ISO 9001

Safety Information - Read First

Use the detector only as specified in this manual, otherwise the protection provided by the detector may be impaired.

International symbols used on the detector and in this manual are explained in Table 2.

Read the **Warnings** and **Cautions** on the following pages before using the detector.



Note

This instrument contains batteries. Do not mix with the solid waste stream. Spent batteries should be disposed of by a qualified recycler or hazardous materials handler.





⚠ Caution

- ⇒ **Warning:** Substitution of components may impair Intrinsic Safety.
- ⇒ **Caution:** For safety reasons, this equipment must be operated and serviced by qualified personnel only. Read and understand the user manual completely before operating or servicing.
- ⇒ Do not use the detector if it is damaged. Before you use the detector, inspect the case. Look for cracks or missing parts.
- ⇒ If the detector is damaged or something is missing, contact [BW Technologies](#) immediately.
- ⇒ Use only a sensor specifically designed for your GasAlertMicro 5 model. (See the section, Replacement Parts and Accessories.)
- ⇒ Calibrate the detector before first-time use and then on a regular schedule, depending on use and sensor exposure to poisons and contaminants. BW recommends at least once every 180 days (6 months).
- ⇒ BW recommends to “bump test” the sensors, before each day’s use, to confirm their ability to respond to gas by exposing the detector to a gas concentration that exceeds the high alarm setpoints. Manually verify that the audible and visual alarms are activated. Calibrate if the readings are not within the specified limits.
- ⇒ It is recommended that the combustible sensor be checked with a known concentration of calibration gas after any known exposure to catalyst contaminants/poisons (sulfur compounds, silicon vapors, halogenated compounds, etc.).
- ⇒ The combustible sensor is factory calibrated to 50% LEL methane. If monitoring a different combustible gas in the % LEL range, calibrate the sensor using the appropriate gas. High off-scale % LEL or % v/v methane readings may indicate an explosive concentration.
- ⇒ Only the combustible gas detection portion of this instrument has been assessed for performance by CSA International.

- ⇒ **Protect the combustible sensor from exposure to lead compounds, silicones, and chlorinated hydrocarbons. Although certain organic vapors (such as leaded gasoline and halogenated hydrocarbons) may temporarily inhibit sensor performance, in most cases, the sensor will recover after calibration.**
- ⇒ **Any rapid up-scaling reading followed by a declining or erratic reading may indicate a gas concentration beyond upper scale limit, which may be hazardous.**
- ⇒ **Use only recommended AA alkaline or NiMH batteries properly charged and installed in the detector case. (See the section, Replacement Parts and Accessories.)**
- ⇒ **Charge NiMH batteries using recommended charger only. Do not use any other charger. Failure to observe this precaution could lead to fire or explosion.**
- ⇒ **Protect the PID sensor from exposure to silicone vapors.**
- ⇒ **The optional BW pump module (M5-PUMP) is certified for use with the GasAlertMicro 5 only.**
- ⇒ **Read and observe all instructions and precautions in the literature provided with the charger. Failure to do so may result in fire, electric shock, or other forms of personal injury or property damage.**
- ⇒ **Extended exposure of the GasAlertMicro 5 to certain concentrations of combustible gases and air may stress a detector element, which can seriously affect its performance. If an alarm occurs due to high concentration of combustible gases, recalibration should be performed, or if needed, the sensor replaced.**
- ⇒ **Do not test the combustible sensor's response with a butane cigarette lighter; doing so will damage the sensor.**
- ⇒ **Do not expose the detector to electrical shock and/or severe continuous mechanical shock.**
- ⇒ **Do not attempt to disassemble, adjust, or service the detector unless instructions for that procedure are contained in the manual and/or that part is listed as a replacement part. Use only BW Technologies replacement parts.**

- ⇒ **Electromagnetic interference (EMI) may cause incorrect operation under certain circumstances.**
- ⇒ **Do not immerse the detector in liquids.**
- ⇒ **The detector warranty will be voided if customer, personnel, or third parties damage the detector during repair attempts. Non-BW Technologies repair/service attempts void this warranty.**

Table 2. International Symbols

| Symbol | Meaning |
|---|--|
|  | Approved to both U.S. and Canadian Standards by the Canadian Standards Association |
|  | European Explosives Protection |
|  | Conforms to European Union Directives |
| BAM | BAM performance verification to European Performance Standards |
| ATEX | Conforms to European ATEX Directives |
| IECEX | International Electrotechnical Commission Scheme for Certification to Standards for Electrical Equipment for Explosive Atmospheres |
|  | Type approved by ABS America for use aboard cargo vessels |

Getting Started

The list below provides the standard items included with your detector. If the detector is damaged or something is missing, contact the place of purchase immediately.

- Batteries (three replaceable alkaline cells or one rechargeable battery pack and the GasAlertMicro 5 Battery Charger);
- Sensors (O₂, combustible (LEL), toxic, and H₂S/CO (dual sensor)/PID);
- Calibration hose and cap;
- Screwdriver;
- Quick reference guide; and
- CD.

To order replacement parts, see the section, Replacement Parts and Accessories.

The detector comes with sensors and alkaline batteries installed. The Maintenance section describes how to replace the batteries.

To become familiar with the features and functions of the detector, study the following figures and tables:

- Figure 1 and Table 3 describes the detector's components.
- Figure 2 and Table 4 describes the detector's display elements.
- Table 5 describes the detector's pushbuttons.

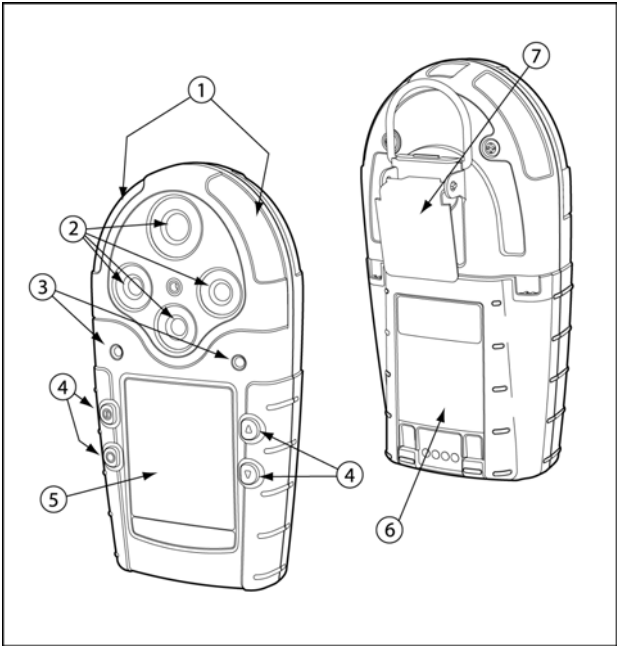

Figure 1. GasAlertMicro 5 Detector

Table 3. GasAlertMicro 5 Detector

| Item | Description |
|------|-------------------|
| 1 | Visual alarm bars |
| 2 | Sensors |
| 3 | Audible alarm |
| 4 | Pushbuttons |
| 5 | Display |
| 6 | Battery pack |
| 7 | Alligator clip |

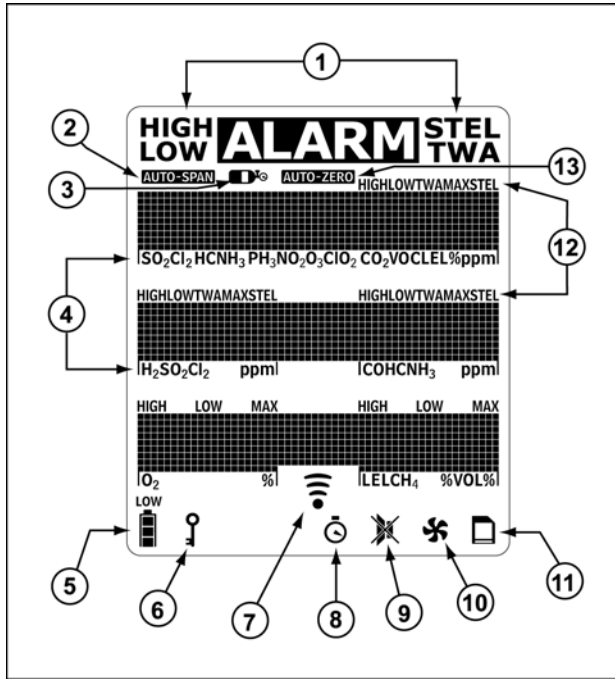

Figure 2. Display Elements

















Table 4. Display Elements

| Item | Description |
|------|---|
| 1 | Alarm condition |
| 2 | Automatically span sensor |
| 3 | Gas cylinder |
| 4 | Gas identifier bars |
| 5 | Battery life indicator |
| 6 | Pass code lock |
| 7 | Data transmission (future use) |
| 8 | Clock |
| 9 | Stealth mode |
| 10 | Optional pump indicator |
| 11 | Optional datalogger card indicator |
| 12 | Alarm condition (low, high, TWA, STEL, or multi-gas) or view TWA, STEL, and maximum (MAX) gas exposures |
| 13 | Automatically zero sensor |

Note

The display backlight automatically activates for 8 seconds when there is an alarm condition and (if enabled) whenever there is insufficient light to view the display. Any pushbutton reactivates the backlight in low-light conditions.

Table 5. Pushbuttons

| Pushbutton | Description |
|---|---|
|  | <ul style="list-style-type: none"> To turn on the detector press . To turn off the detector, press and hold  until countdown is complete. |
|  | <ul style="list-style-type: none"> To increment the displayed value or scroll up, press . To enter the user options menu, press  and  simultaneously and hold until the countdown is complete. To clear the TWA, STEL, and maximum gas exposure readings, press  and  simultaneously and hold until countdown is complete. To view the TWA, STEL, low, and high alarm setpoints of all the sensors and the correction factor (if applicable), press . |
|  | <ul style="list-style-type: none"> To decrement the displayed value or scroll down, press . To initiate calibration and setting alarm setpoints, press  and  simultaneously and hold until countdown is complete. |
|  | <ul style="list-style-type: none"> To view the TWA, STEL, and maximum (MAX) hold readings, press . To acknowledge latched alarms press . |

Activating the Detector

Attach all the accessories before activating the detector (e.g., pump module, sampling probe, hose, etc.).

To activate the detector, press  in a normal atmosphere (20.9% oxygen).

Self-Test

Once the detector is activated, it performs the following checks. (Manually check that all actions occur.)

Note

If any error message appears during the self-test, refer to the Troubleshooting section of the manual.

The detector administers a battery test during start-up. If the battery has insufficient power to operate (at any time during the start-up), the LCD displays the following screen before turning off.

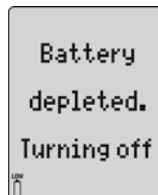

Replace the batteries and restart the detector.

1. The display shows all the display elements as it beeps, flashes, and briefly turns on the backlight.
2. The version and serial number of the detector is then shown on the LCD.



3. Next, the date and time are displayed.

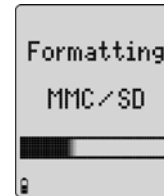
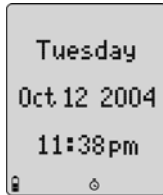

Note

Nothing appears on the display while the detector is running these checks.

*If any type of MMC/SD error message appears, the display shows **Datalogger disabled** before continuing with the start-up sequence.*

Datalogging Unit (Optional)

4. If this is a datalogging unit, the detector will perform the following checks:
- whether a MultiMediaCard (MMC) or secure digital (SD) card is installed;
 - whether the detector can communicate with the card;
 - whether the detector supports the size of the card; and
 - whether the card needs formatting.

If the card needs formatting, the following screen appears as the card is being formatted.

5. The detector then runs a self-test to test the sensors and power.



A screen then appears confirming that the self-test was successful.

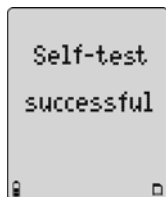

- The LCD then displays the LEL and PID (custom) correction factor (if it is enabled in the user options menu).

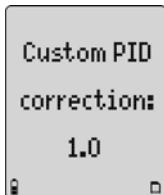
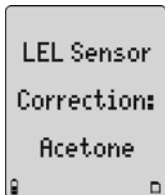

- Next, the display shows the TWA, STEL, low, and high alarm setpoints.

Note

The alarm setpoints on a shipped detector may vary by region. See Resetting Gas Alarm Setpoints.

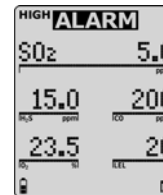
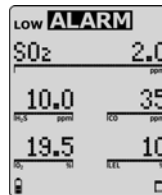
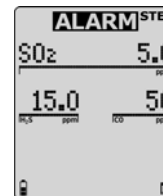
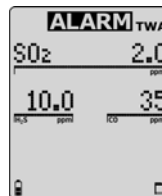

Pump Module (Optional)

- If the optional pump module is attached to the detector, the display reads **Starting sampling pump** to begin the pump test.

During the pump test the pump is calibrated. The pump executes the auto zero function as the following screen appears:

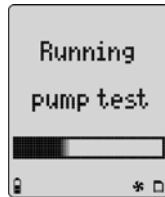

Then the detector begins spanning the pump as the display advises to block the pump inlet.

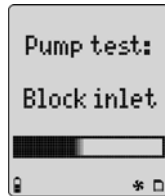

If the pump inlet is not blocked within 10 seconds or the pump test fails, the following screens will appear:

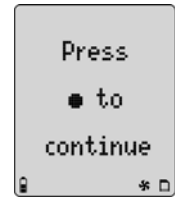
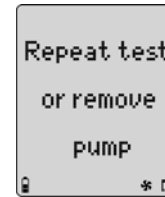
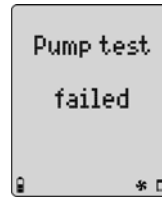

If is not pressed or the pump is not removed within 25 seconds, the detector will administer the pump test again.

If the pump test is successful, the LCD displays **Pump test successful** and then start-up sequence continues.

9. The oxygen sensor is calibrated automatically (unless it is disabled in the user options menu). The detector beeps twice to signal a successful span.

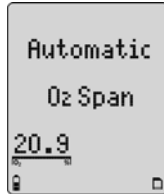

Note

If the automatic oxygen calibration feature has been disabled the display will read **Automatic O₂ span disabled**.

10. Lastly, the display shows the number of days remaining until the next calibration for all the sensors.

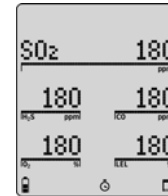
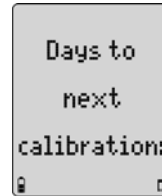

If any sensor is past its calibration due date, the detector displays which sensor is overdue and by how many days before entering normal operation.

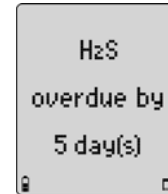
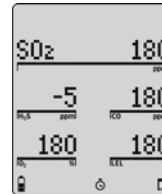

Note

If calibration is overdue for any sensor, ☉ remains on the LCD until calibration is performed for that sensor.

Due-Lock Is Enabled

If **Due-lock** is enabled in the user options menu, the pass code needs to be entered before the detector enters normal operation (refer to the Pass Code Protect Option section).

If an incorrect pass code is entered, the following screen will appear before the detector turns off.

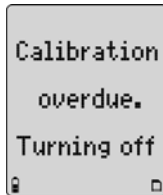

Force Calibration Is Enabled

If **Force cal** is enabled in the user options menu, a calibration is mandatory before the detector enters normal operation (refer to the Calibration and Setting Alarm Setpoints section).

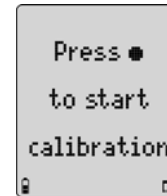
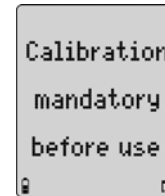

If is not pressed, the following screen appears before the detectors turns itself off.

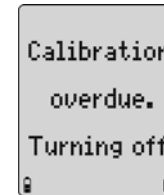

11. Then the detector emits three quick beeps before entering normal operation.

Self-Test Pass

If the detector passes the self-test, the detector begins normal operation. The display shows the ambient gas readings:

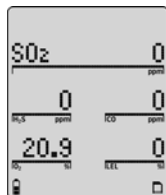

The detector starts recording the maximum gas exposure (MAX) and calculating the short-term exposure level (STEL) and time-weighted average (TWA) exposures.

Self-Test Fail

If a sensor fails the self-test, the display advises which sensor(s) has failed the test.

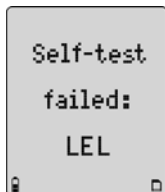

Once the detector enters normal operation, the LCD continues to advise which sensor has failed the self-test. (Refer to the Troubleshooting section.)

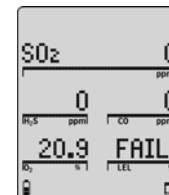

Battery Test

The batteries are tested on activation and continuously thereafter. Battery power is continually displayed during normal operation. If battery power is low,  flashes.

Note

If the confidence beep is on, the audible alarm beeps if the batteries have sufficient power and stops if the battery power is low. See the section, Confidence Beep.

Datalogger Operation

Caution

Do not remove the battery pack while the detector is turned on. Doing so will prevent the datalogger from logging properly.

Datalogger operation is automatic and requires no settings. During normal operation the card is tested every 20 seconds.

Note

The MMC/SD icon (📁) is displayed continuously in datalogger units when the card is inserted. The card is not required for operation of a datalogger unit.

Deactivating the Detector

To turn off the detector, press and hold Ⓞ while it beeps and flashes to the corresponding countdown.

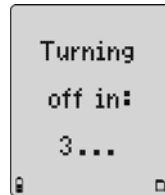

At the end of the countdown, the detector emits one long beep and flash, and the countdown displays **0** before completely turning off.

Note

If Ⓞ is not held down for the complete countdown, the detector will not turn off.

User Options Menu**Note**

If the detector is pass code protected, attempting to enter the user options menu causes the detector to prompt for the pass code before proceeding. See the section, *Pass Code Protection*.

The following are the available user options:

1. Exit;
2. Options: backlight, confidence beep, force cal, due-lock, latch, pass code, safe, and fast pump;
3. Sensors: sensor on/off, span gas, STEL period, TWA method, resolution, % vol CH₄, correction, and auto-cal;
4. Logger;
5. Clock;
6. Language: English, French, German, Spanish, and Portuguese;
7. Tech mode: stealth, sensors, and initialize.

Note

Tech mode is not visible unless it is intentionally entered from within the user options menu. See the *Tech Mode* section.

GasAlertMicro 5

User Manual

To enter the user options menu, press and hold ▲ and ▼ simultaneously as the detector beeps and flashes to the corresponding countdown.

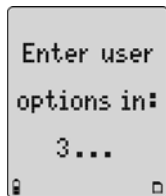

Note

If ▲ and ▼ are not held down for the entire countdown, the detector will not enter the user options menu.

Once the countdown is complete, the revision/serial number screen displays before you see the following screen:



To scroll through the options, press ▼ or ▲. Press ○ to select the option.

Note

If you do not press any pushbuttons within 20 seconds of entering the user options menu, the detector returns to normal operation.

*After selecting an option, press ○ when the cursor is beside **Back** to return to the previous menu.*

Exit User Options Menu

To exit the user options menu and return to normal operation, press ○ when the cursor is beside the **Exit** option. The display will advise that the detector is exiting the user options menu.

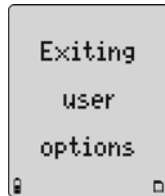

Note

*The user options menu can also be exited by pressing **Ⓞ** until the detector returns to normal operation.*

Options Menu

All of the choices within the **Options** menu are enabled or disabled by pressing **Ⓞ** to toggle the checkbox. If the box is checked, it means the option is enabled. If the box is unchecked, the option is disabled.

After you enter the **Options** menu, there are seven options for you to alter. To return to the main options menu, press **Ⓞ** when the cursor is beside **Back**.

Backlight

The backlight (**Backlight**) option allows you to enable the LCD backlight when the detector is in low-light conditions. Press **Ⓞ** to toggle the option. The detector is shipped with this option enabled.

When disabled, the backlight is only activated when the detector is in alarm mode.

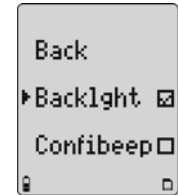

Confidence Beep

The confidence beep (**Confibeep**) notifies that the detector is on and the batteries have sufficient power to respond to a hazardous level of gas and emit an alarm. Instead of beeping when battery power is low, the audible alarm beeps (once every 10 seconds) to advise that the batteries have sufficient power. The confidence beep stops when the battery power is low. Press **Ⓞ** when the cursor is beside **Confibeep** to toggle the option. This option is disabled upon shipment.

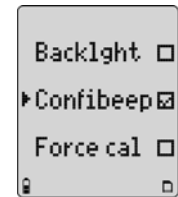

Force Calibration

Enabling the **Force cal** option forces the detector to enter calibration if a sensor is overdue upon start-up. If the detector is not calibrated instantly, the unit will shutdown. The detector is shipped with this option disabled. Pressing \odot toggles this option.

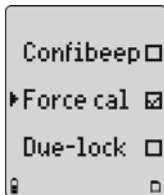

Due-Lock

If **Due-lock** is activated and a sensor is overdue for calibration upon startup, the detector forces you to enter the pass code before entering normal operation. If the correct pass code is not entered, the detector will shutdown. This option is disabled upon shipment.

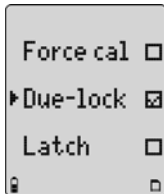

Latched Alarms

The detector is shipped with the latching alarm function (**Latch**) disabled. If the low and high gas alarms are set to latch, the audible, visual, and vibrator alarms persist in the event of an alarm condition until the alarm is acknowledged by pressing \odot and the alarm condition is no longer present.

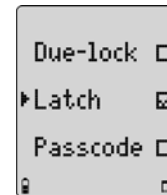

Pass Code Protect

Note

Pass code is provided separately.

Enabling the pass code option prevents unauthorized personnel from having access to the user options menu, calibration function, and alarm setpoint adjust function. The detector is shipped with the pass code protect option disabled. Press \odot when the cursor is beside **Passcode** to toggle the option.

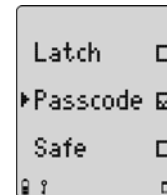

If pass code protect is enabled, press ▲ or ▼ to scroll to the correct pass code when the following display appears. Then press ○ to select that code.

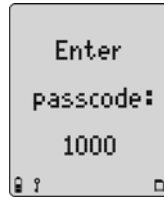

If the pass code is incorrect, the display reads **Passcode incorrect**, the audible alarm beeps three times, and the detector either resumes normal operation or automatically shuts down. If the pass code is correct, the detector proceeds to the next display.

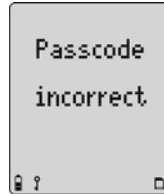

Safe Display

When enabled, the safe display function advises that normal ambient conditions prevail and no gas hazard monitored exist. **Safe** is constantly displayed when all gas levels are normal or below the alarm setpoints.

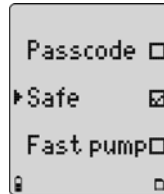

Fast Pump

This option is only applicable if the optional pump is attached to the detector. If the detector has a pump and the sampling hose is longer than 50 ft., the **Fast pump** option needs to be enabled.

Sensor Configuration

Press ○ when the cursor is beside **Sensors** and you will see the following screen:

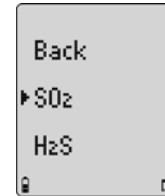

Note

The sensors that are shown on the display is dependent upon the type of sensors that come with the detector.

Press ▲ or ▼ to select a sensor and press ○ to enter its menu. The following information is available for your configuration:

- Enabling/disabling a sensor;
- Setting the span gas value;
- Adjusting the STEL period (not applicable to LEL and O₂ sensors);
- Selecting the TWA method (not applicable to LEL and O₂ sensors);
- Resolution setting (not applicable to CO, LEL, and O₂ sensors);
- % vol CH₄ (LEL sensor only);
- Selecting the correction factor (LEL and PID sensors only); and
- Automatic calibration (O₂ sensor only).

Enable/Disable a Sensor

Warning

Disabling an installed sensor configures the detector to a 1, 2, 3, or 4-gas unit. No protection is now provided for the gas targeted by that sensor(s). Disabling a sensor should be performed with extreme caution.

In the event a sensor fails, disabling the sensor turns off the sensor fail alarm. The sensor should be replaced and enabled as soon as possible.

The detector will function normally with the remaining enabled sensors. The sensor may be enabled again at any time.

Once a sensor's menu is entered, the first setting allows you to enable or disable the sensor. All sensors are enabled upon shipment (as shown by a check in the checkbox). Once the cursor is beside **Sens on**, press ○ to toggle the option. If a sensor is disabled, it can no longer be viewed on the display during normal operation.

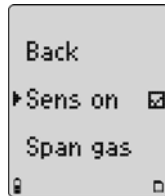

If a sensor is enabled and the sensor is not installed in the detector, the LCD will display the following screen once entering normal operation.

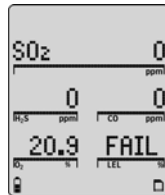

Note

If all the sensors are turned off, the display advises:
Exit not allowed unless at least one sensor is enabled.

Span Gas Value

The **Span gas** option allows you to input a new calibration gas concentration for each sensor. Press \odot when the cursor is beside **Span gas** to enter this option.

To change the calibration gas setting, press \blacktriangle or \blacktriangledown until the display matches the concentration of the calibration gas. Then press \odot to accept the value.

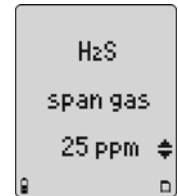

Note

BW recommends that span concentration values be set between specific ranges. Refer to the Calibration and Setting Alarm Setpoints section.

*If you change the calibration gas concentration but pause for 5 seconds before pressing \odot , the detector rejects the new value. The display shows \odot **was not pressed – resetting**, the audible alarm beeps twice, and the detector retains the original value.*

STEL Period

Each sensor has a user settable short-term exposure limit (STEL) period. To enter this option, press \bigcirc when the cursor is beside **STEL period**.

The detector is shipped with the STEL calculation period set to 15 minutes. This value can be adjusted between 5 and 15 minutes. Press \blacktriangle or \blacktriangledown to change the existing STEL value and press \bigcirc to accept the new value.

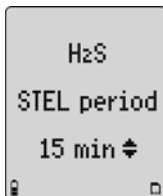

Note

If you do not press any pushbuttons within 10 seconds of entering this option, the detector returns to the previous screen.

*If you change the STEL period but pause for 5 seconds before pressing \bigcirc , the detector rejects the new value. The display shows \bigcirc **was not pressed – resetting**, the audible alarm beeps twice, and the detector retains the original value.*

TWA Method

This option allows the time-weighted average (TWA) to be calculated according to Occupational Safety and Health Administration (OSHA) or American Conference of

Governmental Industrial Hygienists (ACGIH) methods. To enter this option, press \bigcirc when the cursor is beside **TWA method**.

Currently, the **OSHA** checkbox is checked as it is the default TWA method upon shipment. To change this option, place the cursor beside **ACGIH** and press \bigcirc to confirm your selection.

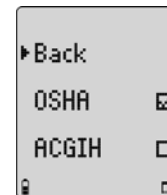

Resolution

This option allows you to choose the resolution with which the gas measurement is displayed (either regular or extra resolution). You can enter this option by pressing \bigcirc when the cursor is beside **Resolution**.

The detector is shipped with **Regular** resolution (1 ppm) as its default (as indicated by a check in the corresponding checkbox). To change your setting, place the cursor beside **Extra** (0.1 ppm) and press \bigcirc . A check will appear in the corresponding checkbox confirming your selection.

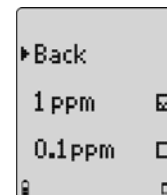

Note

Regular resolution for O₃ and ClO₂ sensors is 0.1 ppm, while extra resolution is 0.01 ppm.

CO, O₂, and LEL sensors do not have resolution settings.

% Vol CH₄

This option is only applicable to LEL sensors. If this option is enabled, it shows the LEL reading in % vol assuming a methane environment. To enable this option, press when the cursor is beside **% vol CH₄** and a check appears in the corresponding checkbox.

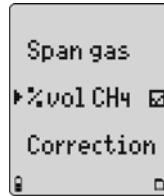

Correction Factor

LEL Sensor

Entering the correction factor option allows you to enter compensation factors for hydrocarbons other than methane. This simulates as if you calibrated to a non-methane hydrocarbon. To enter this option, press when the cursor is beside **Correction** within the LEL sensor menu.

Once you are inside the correction factor library, make your selection and press . A check will appear in the corresponding checkbox to indicate your selection.

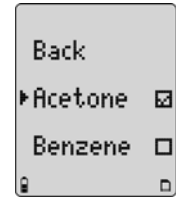

PID Sensor

Please contact BW Technologies for more information.

Automatic Oxygen Calibration

When the **Autocal** option is enabled, it forces the detector to automatically calibrate the oxygen sensor upon startup. When the cursor is beside the **Autocal** option, press to toggle its functionality. The automatic calibration option is enabled upon shipment.

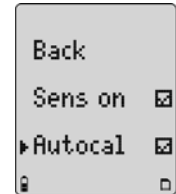

Logger Option

The detector is shipped with the datalogger set to record a sample every 5 seconds. The sample rate can be adjusted between 1 and 127 seconds. To enter this option, press when the cursor is beside **Logger**.

Once inside the option, press ▲ or ▼ to change the existing logger rate and press ○ to accept the new rate.

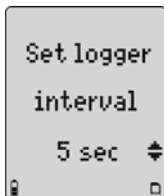

Clock Option

To set or adjust your date and clock setting, press ○ when the cursor is beside the **Clock** option. Once you have entered the clock option, you will see the following screen:

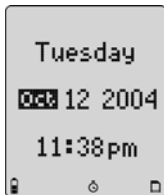

Currently, the month is highlighted indicating that it is the first setting to change.

The date and time are set in the following order:

- Month;
- Day;
- Year;
- Hour; and
- Minutes.

Press ▲ and ▼ to scroll to the correct month and press ○ to confirm your selection. Continue with this process until you have confirmed every setting for the date and time. Once you have finished setting the clock, the detector will beep twice before returning to the main user options menu.

Language Selection

The detector is shipped with English as the default displayed language. You can choose to view the display in these additional languages:

- French (**Français**);
- German (**Deutsch**);
- Spanish (**Español**); and
- Portuguese (**Prtuguês**).

Press ▼ or ▲ to scroll through the selections and press ○ to select the new language. The checkbox appears beside the language of your choice.





Tech Mode

Warning

Tech mode should only be entered by trained personnel.

The following options are found in tech mode:

- Stealth mode;
- Sensors;
- Pump; and
- Initialize.

To enter tech mode you must ensure that the cursor is pointed to **Language** in the user options menu. Press and hold , then , and lastly . Once  is pressed, the detector emits two quick beeps and **Tech mode** appears below the **Language** option.

Stealth Mode

The detector is shipped with stealth mode disabled. When it is activated, stealth mode disables the beepers, backlight (even if the backlight option is enabled), and alarm LEDs. Press  when the arrow is beside **Stealth** to enable this option.



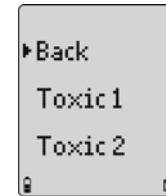

Sensors

Press  when the arrow is beside **Sensors** to enter this option. You will see the following screen:



To enter either option, press  when the arrow is beside either **Toxic 1** or **Toxic 2**.

Once you have entered either option a list of available toxic sensors is shown. The active toxic sensor is indicated by a checkbox beside the gas measured. To change sensors, press  or  until the arrow is beside the sensor of your choice and press  to accept this change.





Once you exit the user options menu, **Unit must restart to reconfigure** appears on the display and the detector runs a self-test to reconfigure itself to the new sensor.

Note

The Toxic 2 list includes the H₂S/CO COSH sensor.

Pump

If you have just attached the optional motorized pump to your detector, the flow rate needs to be set before the pump can be used.

Press  when the cursor is beside **Pump** to enter this option. Press  and  to scroll to the factory calibrated number that BW provides and press  to accept the chosen value.

Once the flow rate has been chosen, you must exit the user options menu. The detector automatically launches a pump test before returning to normal operating mode.

Initialize

This option allows you to set the detector back to its default factory settings. To enter this option, press  when the cursor is beside **Initialize**.

Once you enter the option, you will see the following screen.

If you press  (**No**), the screen displays **Could not initialize** and the detector exits the option.

If you press  (**Yes**), the screen displays **Initializing** as the bar fills to complete the function. Once initializing is complete, the unit exits the option.

Alarms

The following table describes the detector alarms and shows how the display looks for each alarm.

During an alarm condition, the detector activates the backlight and the display shows the current ambient gas reading.

If more than one type or level of alarm exists at the same time, a multi-gas alarm will result.

To change the factory-set alarm setpoints, refer to the section Calibration and Setting Alarm Setpoints.

Table 6. Alarms

| Alarms | Display | Alarms | Display |
|--|---|--|---|
| <p>Low Alarm:</p> <ul style="list-style-type: none"> • Fast beep • Slow flash • ALARM and target gas bar flash • Vibrator alarm activates |  | <p>High Alarm:</p> <ul style="list-style-type: none"> • Constant beep • Fast flash • ALARM and target gas bar flash • Vibrator alarm activates |  |
| <p>STEL Alarm:</p> <ul style="list-style-type: none"> • Constant beep • Fast flash • ALARM and target gas bar flash • Vibrator alarm activates |  | <p>TWA Alarm:</p> <ul style="list-style-type: none"> • Fast beep • Slow flash • ALARM and target gas bar flash • Vibrator alarm activates |  |

Table 6. Alarms (cont.)





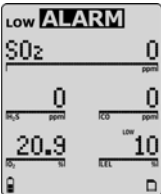
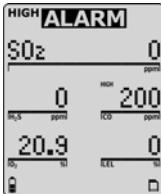
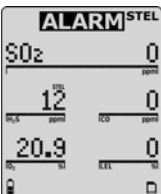
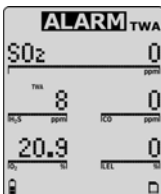

| Alarms | Display | Alarms | Display |
|--|---|--|---|
| <p>Multi-Gas Alarm:</p> <ul style="list-style-type: none"> Alternating low and high alarm beep and flash ALARM and target gas bars flash Vibrator alarm activates |  <p>The display shows 'LOW ALARM TWA' at the top. Below it, 'SO2' is displayed with a '0' ppm reading. There are two horizontal bars: the left one is labeled 'LOW' and has a value of '10', while the right one is labeled 'TWA' and has a value of '35'. At the bottom, '20.9' is shown with a '0' ppm reading. A battery icon is visible in the bottom left corner.</p> | <p>Over Range Alarm: (Over Level Exposure)</p> <ul style="list-style-type: none"> Fast beep and flash ALARM and target gas bar flash Vibrator alarm activates |  <p>The display shows 'HIGH ALARM' at the top. Below it, 'SO2' is displayed with a '0' ppm reading. There are two horizontal bars: the left one is labeled 'LOW' and has a value of '0', while the right one is labeled 'TWA' and has a value of '0'. At the bottom, '20.9' is shown with a '0L' ppm reading. A battery icon is visible in the bottom left corner.</p> |
| <p>Sensor Alarm:</p> <ul style="list-style-type: none"> One beep, one flash, and one vibrate every 10 seconds FAIL flashes above the failed sensor |  <p>The display shows 'ALARM' at the top. Below it, 'SO2' is displayed with a '0' ppm reading. There are two horizontal bars: the left one is labeled 'FAIL' and has a value of '20.9', while the right one is labeled 'TWA' and has a value of '0'. A battery icon is visible in the bottom left corner.</p> | <p>Automatic Shutdown Alarm:</p> <ul style="list-style-type: none"> Eight beeps and flashes LOW displays Vibrator alarm temporarily activates |  <p>The display shows 'Battery depleted. Turning off' in the center. A battery icon is visible in the bottom left corner.</p> |
| <p>Low Battery Alarm:</p> <ul style="list-style-type: none"> One beep and one flash every 25 seconds LOW flashes |  <p>The display shows 'SO2' at the top with a '0' ppm reading. Below it, there are two horizontal bars: the left one is labeled 'LOW' and has a value of '0', while the right one is labeled 'TWA' and has a value of '0'. At the bottom, '20.9' is shown with a '0' ppm reading. A battery icon is visible in the bottom left corner.</p> | <p>Normal Shutdown:</p> <ul style="list-style-type: none"> Three beeps and flashes |  <p>The display shows 'Turning off in: 3...' in the center. A battery icon is visible in the bottom left corner.</p> |

Table 6. Alarms (cont.)

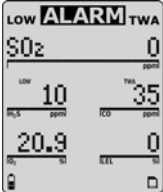
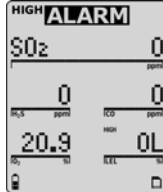
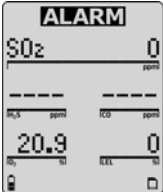
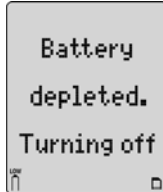
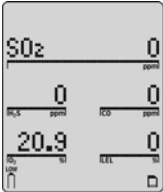
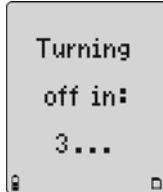
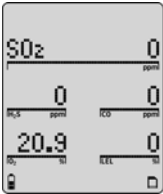
| Alarms | Display | Alarms | Display |
|---|---|---|---|
| <p>Confidence Beep:</p> <ul style="list-style-type: none"> Two fast beeps every 10 seconds |  | <p>Pump Alarm:</p> <ul style="list-style-type: none"> Slow beep and flash ALARM and  flash |  |
| <p>MMC Fail Alarm:</p> <ul style="list-style-type: none"> One beep every 5 seconds  flashes |  | | |

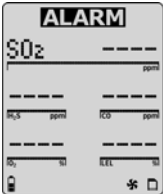
Note

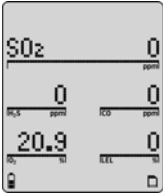
If the latched alarm function is activated, the audible and visual alarms continue to beep and flash until the alarm condition is acknowledged. To acknowledge a latched alarm, press . The alarms cannot be deactivated if an alarm condition is still present.

If the detector is in stealth mode, it only vibrates in alarm mode (the audible and visual alarms are disabled).

Gas Exposures Computed

⚠ Warning

To avoid possible personal injury, do not turn off the detector during a work shift. TWA and STEL readings reset if the detector is deactivated for more than 5 minutes.

Table 7. Computed Gas Exposures

| Gas Exposure | Description |
|----------------------|--|
| TWA (toxic only) | Time-weighted average based on accumulated exposure to toxic gases averaged over a work day according to OSHA or ACGIH method. |
| STEL (toxic only) | Short-term exposure limit to gas based on a 5-15 minute user selectable period. |
| Maximum* (peak) | Maximum concentration encountered during work shift. |

* For oxygen, it is the highest or the lowest concentration encountered.

Viewing Gas Exposures

Press **○** until the display shows the maximum gas exposures.

The display then shows the TWA gas exposures.

Then the STEL gas exposures.

Clearing Gas Exposures

To clear the maximum gas, TWA, and STEL exposure readings, press and hold **○** and **▲** simultaneously and the detector displays the following and administers a countdown.

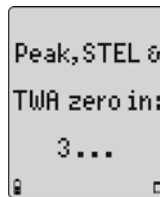

Note

*If you do not hold **○** and **▲** for the entire countdown, the maximum gas, TWA, and STEL exposure readings will not clear.*

Gas Alarm Setpoints

The detector's gas alarm setpoints trigger the gas alarms, which are described in the table below.

Table 8. Gas Alarm Setpoints

| Alarm | Condition |
|-----------------|--|
| Low alarm | <i>Toxics and combustibles:</i> Ambient gas level above low alarm setpoint. <i>Oxygen:</i> Ambient gas level may be set to above or below 20.9%. |
| High alarm | <i>Toxics and combustibles:</i> Ambient gas level above high alarm setpoint. <i>Oxygen:</i> Ambient gas level may be set to above or below 20.9%. |
| TWA alarm | <i>Toxic only:</i> Accumulated value above the TWA alarm setpoint. |
| STEL alarm | <i>Toxic only:</i> Accumulated value above the STEL alarm setpoint. |
| Multi-gas alarm | Two or more gas alarm conditions. |

Viewing the Alarm Setpoints

To view the current alarm setpoints of all of the sensors, press  during normal operation.

Resetting Gas Alarm Setpoints

Note

Standard factory alarm setpoints will vary by region.

Occupational Safety and Health Association (OSHA) standard settings are used as an example.

The following table lists the factory alarm setpoints.

Table 9. Sample Factory Alarm Setpoints

| Gas | TWA | STEL | Low | High |
|------------------|---------|----------|------------|------------|
| O ₂ | N/A | N/A | 19.5% vol. | 23.5% vol. |
| LEL | N/A | N/A | 10 % LEL | 20% LEL |
| CO | 35 ppm | 50 ppm | 35 ppm | 200 ppm |
| H ₂ S | 10 ppm | 15 ppm | 10 ppm | 15 ppm |
| PH ₃ | 0.3 ppm | 1.0 ppm | 0.3 ppm | 1.0 ppm |
| SO ₂ | 2 ppm | 5 ppm | 2 ppm | 5 ppm |
| Cl ₂ | 0.5 ppm | 1.0 ppm | 0.5 ppm | 1.0 ppm |
| NH ₃ | 25 ppm | 35 ppm | 25 ppm | 50 ppm |
| NO ₂ | 2.0 ppm | 5.0 ppm | 2.0 ppm | 5.0 ppm |
| HCN | 4.7 ppm | 10.0 ppm | 4.7 ppm | 10.0 ppm |
| ClO ₂ | 0.1 ppm | 0.3 ppm | 0.1 ppm | 0.3 ppm |
| O ₃ | 0.1 ppm | 0.1 ppm | 0.1 ppm | 0.1 ppm |
| VOC | 50 ppm | 100 ppm | 50 ppm | 100 ppm |

GasAlertMicro 5

User Manual

To change the factory-set alarm setpoints, refer to the section Calibration and Setting Alarm Setpoints.

Note

You can disable an alarm by setting the alarm setpoint to 0.

Stopping a Gas Alarm

The low and high alarms stop when the ambient gas level returns to the acceptable range.

Note

If alarms are set to latch, press  to reset the alarms.

The detector computes the TWA value based on the OSHA or ACGIH standard (see TWA Method) and the STEL value based on a user selectable 5 to 15 minute period (see STEL Period).



Sensor Alarm

The detector tests for a missing or defective sensor during the activation self-test. If a sensor fails the self-test, **FAIL** appears above the location of the given sensor. Refer to the Troubleshooting section.

Pump Alarm

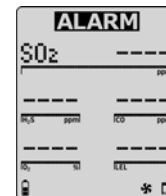
The external pump draws air over the sensors. If the pump stops working or becomes clogged, the detector activates the pump alarm.



The pump alarm continues until the blockage is cleared or it is acknowledge by pressing . If  is pressed, the detector administers a pump test to recalibrate the pump module (refer to the Pump Test section). If the pump test is successful, the detector will return to normal operation. If not, the pump alarm will continue.

Low Battery Alarm

The detector tests the batteries on activation and continuously thereafter. Battery power is continually displayed during normal operation. If the battery voltage is low, the detector activates the low battery alarm.

The low battery alarm continues until you replace the batteries or the battery power is almost depleted. If the battery voltage drops too low, the detector executes an automatic shutdown.

Note

If the confidence beep is on, the audible alarm does not beep during a low battery alarm (see the section, Confidence Beep). Typically, the low battery alarm continues for 30 minutes before an automatic shutdown.

Automatic Shutdown Alarm

If the battery voltage is in immediate danger of dropping below the minimum operating voltage, the audible alarm beeps eight times and the visual alarm flashes eight times. After

3 seconds, the display blanks out and the detector stops normal operation. The display shows LOV periodically until the battery power is depleted.

Replace the batteries. See the section, Replacing the Batteries.

Calibration and Setting Alarm Setpoints

Guidelines

When calibrating the detector, adhere to the following guidelines:

- Recommended gas mixture:
 CO: 50 to 500 ppm balance N₂
 H₂S: 10 to 100 ppm balance N₂
 PH₃: 1 to 5 ppm balance N₂
 SO₂: 10 to 50 ppm balance N₂
 Cl₂: 3 to 25 ppm balance N₂
 NH₃: 20 to 100 ppm balance N₂
 NO₂: 5 to 50 ppm balance N₂
 HCN: 5 to 20 ppm balance N₂
 ClO₂: 0.1 to 1.0 ppm balance N₂
 O₃: 0.1 to 1.0 ppm balance N₂
 VOC: 100 ppm isobutylene
 LEL: 10 to 100% LEL or .5 to 5% by vol. methane balance air
 O₂: clean air, 20.9 %
- CG-Q58-4 and CG-Q34-4 Calibration Gas (4-gas mix) are available from BW Technologies. See the section, [Replacement Parts and Accessories](#).

- Calibration accuracy is never better than the calibration gas accuracy. BW Technologies recommends a premium-grade calibration gas. Gases with the National Institute of Standards and Technology (NIST) traceable accuracy will improve the validity of the calibration. Do not use a gas cylinder beyond its expiration date.
- Calibrate a new sensor before use. Install the sensor, activate the detector, and allow the sensor to stabilize before starting calibration (used: 60 seconds; new: 5 minutes).
- Calibrate the detector at least once every 180 days (for HCN detectors calibrate at least once every 90 days), depending on use and sensor exposure to poisons and contaminants.
- Calibrate the detector if the ambient gas display varies at start-up.
- It is best to calibrate the sensor before changing the alarm setpoints.
- Calibrate only in a clean atmosphere that is free of background gas.
- To disable an alarm, set the alarm setpoint to 0.

- The oxygen sensor can be automatically calibrated each time upon activation (if this feature is enabled). Activate the detector in a normal (20.9% oxygen) atmosphere.
- The detector should be allowed to stabilize for 1 minute, after activation, prior to calibration, or a bump test.
- If you require a certified calibration, contact [BW Technologies](#).

Note

A generator must be used to calibrate O₃, ClO₂, and Cl₂ sensors.

Diagnostics Protection

The detector tests the ambient air (auto zero) and the test gas that is applied (auto span) to ensure it meets expected values.

In auto zero, if any background target gas is present, the sensor(s) affected will read **Err** and exit the auto zero function, retaining the previous set value(s).

In auto span, if any target gas is not present or does not meet expected values, the display will advise you and exit calibration mode, retaining the previous set value(s).

Applying Gas to the Sensors

The calibration hose, which is shipped with the detector, simplifies sensor testing and calibration. Table 10 and Figure 3 show how to use it when applying gas to the sensors.

Note

The calibration cap should only be used during the calibration process.

Table 10. Applying Gas to the Sensors

| Item | Description |
|------|------------------------------|
| 1 | Detector and calibration cap |
| 2 | Calibration hose |
| 3 | Regulator and gas cylinder |

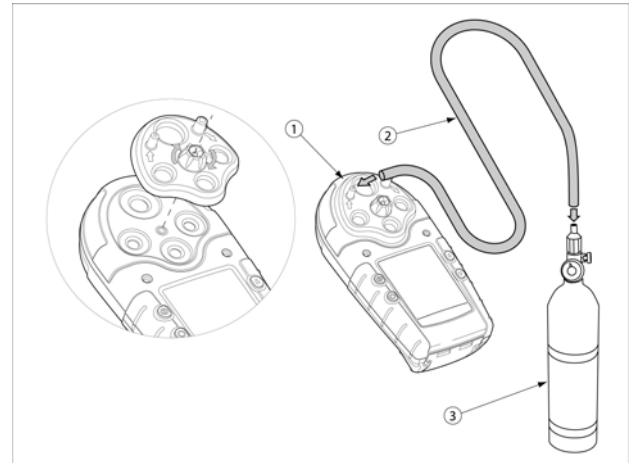

Figure 3. Applying Gas to the Sensors

Calibration Procedure

To calibrate the detector and set the alarm setpoints, perform the following procedure.

Note



To bypass a step during the calibration process (after auto zero), press Ⓢ .

Calibrate O₂ in clean air.

Start Calibration

Note

Verify that the calibration gas you are using matches the span concentration value(s) in the detector. See the section, *Span Gas Value*.

1. In a clean atmosphere, press and hold  and  simultaneously as the detector beeps, flashes, and vibrates to the corresponding countdown. The display shows the following to indicate that it has entered calibration mode.

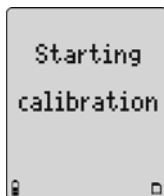

Auto Zero and Oxygen Sensor Calibration

2. The display flashes **AUTO-ZERO** while the detector automatically zeroes the toxic and combustible sensors and calibrates the oxygen sensor. The display will notify you if the auto zero has failed for a sensor.

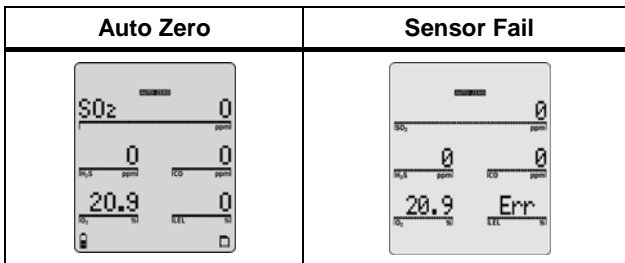

The audible alarm then beeps twice.

Note

Do not apply the calibration gas at this point, otherwise the auto zero step will fail.

Pass Code Protect Activated

After a successful auto zero, the detector asks for the pass code if the detector is pass code protected. The pass code needs to be entered before proceeding to auto span and the alarm setpoints.

3. The display then requests the pass code (refer to Pass Code Protect).

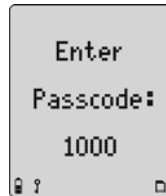

Note

If the correct code is entered, the detector beeps twice and automatically proceeds to span the sensors.

If the incorrect pass code is entered or \bigcirc is not pressed within 5 seconds, the display advises that the pass code is incorrect. The detector will then save the calibration before returning to normal operation.

Auto Span

You can calibrate anywhere from one to all five sensors as desired.

4. The display now prompts you to either apply calibration gas to the sensors or press Ⓢ to bypass the span.

5. Attach the calibration cap and apply gas to the sensor at a flow rate of 250 to 500 ml/min. (for NH_3 and Cl_2 : 1000 ml/min.). (Refer to Figure 3. Applying Gas to the Sensors.) The display flashes Ⓢ as it spans the sensors.

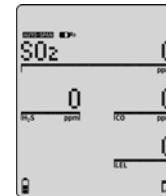

When the detector senses a sufficient amount of gas concentration (30 seconds), the audible alarm beeps once. The detector then begins spanning the sensor(s) (2 minutes).

No Gas Detected

If the detector does not detect any gas within 2 minutes, it will display the following screens.

Press ⬆ to try calibrating with another gas bottle or press ⬇ to end the span. (If you choose to end the span, go to step #12.)

Large Span

If the span adjustment is unusually large (more than 20%), the detector will advise which sensor had the large span change.

Confirm that the calibration gas bottle you are using is correct and that the span concentration value(s) of the detector matches the value of the calibration gas bottle. See *the section, Set Span Concentration Values*.

If the calibration adjustment is expected, press to accept this span. If the calibration adjustment is not expected or the span concentration value does not match the calibration gas bottle, press to reject the span and calibrate that sensor again.

Did Not Reach Target Span

If the span did not reach its target (span gas concentration within the user options menu), it will advise which sensor did not reach its target and ask whether or not you would like to keep the span.

This warning usually indicates that the calibration bottle is past its expiry date and you should calibrate the sensor with a new bottle.

Successful Span

If the sensor(s) has spanned successfully, the audible alarm beeps three times and the following screens will appear.

If there are more sensors to span, remove the existing calibration bottle, connect the next bottle, press , and repeat step #5 to span the other sensor(s).

If you choose not to span the other sensors, press to continue with the calibration process.

If all of the sensors have been spanned, the following screen appears before the calibration procedure continues.

Unsuccessful Span

If all sensors fail the span, the screen shows the following:

If only some sensors failed the span, the detector bypasses the span for the failed sensor(s). **Err** appears beside the failed sensor once the detector is in normal operation.

Press to exit, and then restart calibration in an atmosphere that is clear of the targeted gases. If the auto span fails a second time, restart the detector to test the sensors.

Note

The detector will not span a sensor if:

- *You do not apply gas to the sensor.*
- *The sensor fails to detect at least one-half of the expected gas concentration in the first 30 seconds.*
- *The gas concentration drops below one-half of the expected gas level during the 2 minute span.*

If you apply gas to a sensor and the detector fails to span the sensor, repeat the calibration process using a new gas cylinder. If the sensor fails the span a second time, replace the sensor. See the section, Replacing a Sensor or Sensor Filter.

Setting the Calibration Due Date

Note

If a sensor does not successfully span, you cannot change its calibration due date.

After span is complete, you can change the next calibration due date for each sensor. The following screen is displayed.

If you press **Ⓢ** to bypass this section, go to step #10.

If you press **○**, the detector shows the following screen before the due date for the first toxic sensor is displayed.

Note

Calibration due dates are always set in the following order: toxic 1, toxic 2, LEL, and O₂.

6. To change the calibration due date (1 to 365 days), press **▼** or **▲** until the display shows the new value.
7. Press **○** to save the displayed value. The detector will then proceed to the next sensor.
8. Repeat steps #6-7 to set the calibration due date for the rest of the sensors.
9. Once all of the sensors calibration due dates have been set, the detector will emit two quick beeps before proceeding to the alarm setpoint section.

If a sensor did not successfully span, pressing **▼** or **▲** will cause the following screens to appear for the applicable sensor:

The display then proceeds to the next sensor's due date.

Note

If you do not press any pushbuttons within 5 seconds, the detector automatically retains the previous calibration due date.

Alarm Setpoints

Factory alarm setpoints may vary by region. Refer to the Resetting Gas Alarm Setpoints section for an example of these factory alarm setpoints. Set the setpoints as desired.

Note

Alarms may be set anywhere within the detection range for the sensor. See the Specifications section or set to zero for off.

If you do not press any pushbuttons within 10 seconds, the detector automatically retains the previous alarm setpoint.

*If you change an alarm setpoint but pause for 10 seconds before pressing **○**, the detector will display **Err** and reject the new value.*

Setting the TWA Alarm Setpoint

The display shows the TWA alarm setpoint for SO₂:

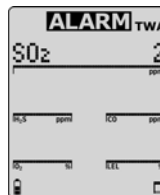

10. To change the TWA alarm setpoint for this sensor, press **▼** or **▲** until the display shows the new value. Press **○** to save the displayed value.

Setting the STEL Alarm Setpoint

The display shows the STEL alarm setpoint for SO₂:

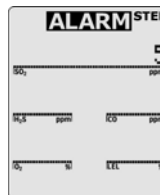

11. To change the STEL alarm setpoint for this sensor, press **▼** or **▲** until the display shows the new value. Press **○** to save the displayed value.

Setting the Low Alarm Setpoint

The display shows the low alarm setpoint for SO₂:

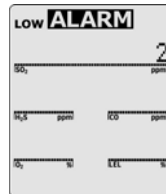

12. To change the low alarm setpoint for this sensor, press or until the display shows the new value. Press to save the displayed value.

Setting the High Alarm Setpoint

The display shows the high alarm setpoint for H₂S:

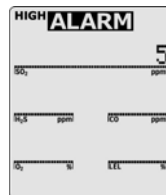

13. To change the high alarm setpoint for this sensor, press or until the display shows the new value. Press to save the displayed value.

Setting the Remaining Alarm Setpoints

14. Repeat steps 3 through 6 to set alarm setpoints for the other sensors. The audible alarm will beep four times when the alarm setpoint function is complete.

Finish Calibration

15. The detector displays the following to indicate that the calibration process is complete and then enters normal operation.

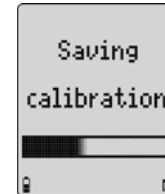

Verification

After calibration is complete and the detector is in normal operating mode, test it using a gas cylinder other than the one used in calibration. The gas concentration should not exceed the sensor's detection range. Confirm that the display shows the expected concentration.

Datalogger

The datalogger version allows the detector to record various information so the user can compile a report.

Datalog

Please contact BW Technologies for more information.

MultiMediaCard Compatibility

A standard 32 MB MMC Flash Memory card is supplied with the detector. When purchasing additional MultiMediaCards, BW Technologies recommends MMC flash memory cards that contain between 32 MB and 256 MB storage capacity.

MultiMediaCard(s) compatible with the MMC specification will always have the exact word “MultiMediaCard“ or “MMC“ written on the disk or package. Cards that do not contain these exact words are not a MultiMediaCard.

The “MMC” is not the same as the following:

- MultiMedia card
- Multi media card
- SmartMedia
- CompactFlash
- Memory Stick

MMC cards are available through retailers throughout the world. They are also available through mail order and Internet vendors.

MultiMediaCard Troubleshooting

A warning message will display if the card is not inserted.

Note: No data card is installed. The card is not required for operation of the User Downloadable Datalogger models.

A new MMC card is automatically formatted when it is inserted in the detector. When installing any new or blank MMC card into the detector the LCD displays **the card is blank**, then the detector proceeds to auto-format the MMC card.

Recovering Data Files

If the MMC card is reformatted or erased accidentally by your computer application, the recorded data file can be recovered.

First ensure the card is inserted properly in the card reader. If the recorded data file is not visible ensure that:

The card reader is visible in the **My Computer** window.



- If not, verify that the card reader is inserted correctly and that the connections are secure.

- In the “Removable Disk” drive window, ensure **All Files** are selected in the **File Types** field.
- “Reformat and Recover Deleted Files”

Insert the MMC card back into the detector. The detector will reformat. The file should now be available.

If the recorded data file (Logfile0.csv), is still not visible:

- Format the MMC card in Windows.
- Remove the MMC card from the card reader.
- Insert the MMC card back into the detector.
- Allow the detector to reformat the MMC card.
- Remove the MMC card from detector.
- Insert the MMC card back into card reader.
- Select the **My Computer** icon.
- Select the drive that corresponds to the card reader.
- The **Recorded Data File (Logfile0.csv)**, will now be visible.



If the Recorded Data File is still not visible, insert the MMC card into the detector and turn it on. The LCD will advise: **Error. Data file has been deleted.** You will then be given the choice of erasing or restoring the data. Use  or  to scroll through the options. Press  to confirm your choice.

To restore the data, select **Restore**. The detector will then restore the data to the MMC card, and will resume the start-up procedure.

To permanently erase the data on the MMC, select **Erase**. The display will then read, **Are you sure?**

Note

Once data is erased using this process, it cannot be retrieved.

Press  to confirm your choice or press  to abort. If you choose to abort the erasing procedure, the display will read, **Erase aborted.**

The display will then read **Note: Card cannot be used Pull out the card to continue.** Insert a new card or erase the data. Once you confirm your decision to erase the data on the MMC card or there is a new card inserted the detector will resume normal operation.

Direct Import into Compatible Programs

Information from this point on applies only to users who are not using the Fleet Manager plug-in. The following information applies to direct data import into Excel and other compatible programs. To use the datalogger data, insert the data card into a computer adapter and open the data file **LOGFILE0.CSV** using spreadsheet or database software.

Word processors and text editors may also be used, but performance may be poor, since the datalogger file is at least 16 megabytes in size.

Data for user-accessible models is comma-separated-values (CSV) format. The data order is:

- Date, day, time
- H₂S, CO, Combustibles, O₂
- H₂S TWA, CO TWA
- Status codes, serial number

Recorded data includes eight single-character unit status codes. The eight characters represent codes for the H₂S, CO, combustibles, and O₂ sensors, datalogger, unit battery status, and unit alarm status. A summary of most of the available codes can be seen in table A.

Importing the Data File Into Compatible Desktop Applications

Information from this point forward only applies to users who are not using the Fleet Manager plug-in.

The recorded data can be loaded into most spreadsheet, database, word processor, or text editor applications. Some examples are:

- Microsoft® Excel 95, 98 and 2000;
- Quattro Pro;
- Lotus 1-2-3;
- Microsoft® Access; and
- Microsoft® Word.

Determining Application Compatibility

To determine if the application selected is compatible:

- Insert MMC card in to the card reader;
- Open desired application;
- Use the applications **File/Open** menu options to locate and open the data file.

If the recorded data file is compatible with the application, it will open. If not the application will report an error in opening the file.

Important

Some applications have an internal file size limits, and may not load the entire file. Check the application's specifications prior to use.

Table 11: Datalogger Status Codes

| Codes | Explanation |
|----------------------|--------------------|
| General Codes | |
| — | Normal operation |
| G | Backlight is on |
| Sensor Codes | |
| L | Low alarm |
| H | High alarm |

| | |
|-------------------|-----------------------------------|
| T | TWA alarm |
| U | Dual alarm (low and TWA alarms) |
| V | Dual alarm (high and TWA alarms) |
| s | STEL alarm |
| u | Dual alarm (low and STEL alarms) |
| v | Dual alarm (high and STEL alarms) |
| w | Dual alarm (TWA and STEL alarms) |
| x | Triple alarm (TWA, STEL and low) |
| y | Triple alarm (TWA, STEL and high) |
| O | Sensor is over-ranged |
| C | Calibrating |
| F | Sensor failure |
| 1 | Alarm setpoint 1 (low alarm) |
| 2 | Alarm setpoint 2 (high alarm) |
| 3 | Alarm setpoint 3 (TWA alarm) |
| 4 | Alarm setpoint 4 (STEL alarm) |
| D | Calibration due date (in days) |
| E | Last calibration (in days) |
| Z | Auto-zeroing |
| Pump Codes | |
| P | Pump alarm |

| | |
|-----------------------------|---------------------------|
| F | Pump failure |
| Battery Status Codes | |
| — | Batteries OK |
| B | Low battery alarm |
| K | Confidence beep is active |
| Alarm Status Codes | |
| L | Low alarm |
| H | High alarm |
| T | TWA alarm |
| M | Multi-gas alarm |
| C | Calibration |
| Q | Manual shutdown |
| S | Automatic shutdown |
| F | Self-test fail |
| R | Real-time clock failure |

Note: TWA readings greater than 99 are recorded as OL.

Maintenance

To keep the detector in good operating condition, perform the following basic maintenance as required:

- Calibrate, bump test, and inspect the detector at regular intervals.
- Keep an operations log of all maintenance, calibrations, bump tests, and alarm events.
- Clean the exterior with a soft damp cloth. Do not use solvents, soaps, or polishes.
- Do not immerse the detector in liquids.

Replacing the Batteries

⚠ Warning

To avoid personal injury:

- ⇒ **Replace the batteries as soon as the detector emits a low battery alarm.**
- ⇒ **Use only batteries recommended by BW Technologies to prevent damage or personal injury.**
- ⇒ **Use only approved batteries, properly installed in the detector case. See the section [Specifications](#) for approved batteries.**

- ⇒ **Charge batteries using only a recommended charger. Do not use any other charger. Failure to observe this precaution can lead to fire or explosion.**

Note

Both the rechargeable battery pack and the alkaline battery pack are hot-swappable, but replacing the alkaline batteries needs to be done in a non-hazardous location.

To preserve battery life, turn off the detector when you are not using it.

To replace the alkaline batteries, refer to the following figure, table, and set of instructions. (To charge the rechargeable battery pack, refer to the *GasAlertMicro 5 Battery Charger manual*.)

1. Open the latch on the bottom of the detector.
2. Remove the battery pack by lifting the end of the pack away from the detector.
3. Unscrew the two captive screws on the battery pack and open the pack.
4. Install the three alkaline batteries and screw the battery pack back together.

5. Insert the battery pack back into place and secure the latch.

Table 12. Replacing the Batteries

| Item | Description |
|------|--------------------|
| 1 | Detector |
| 2 | Latch |
| 3 | Battery pack |
| 4 | Battery tray |
| 5 | Captive screws (2) |
| 6 | Alkaline batteries |
| 7 | Battery shell |

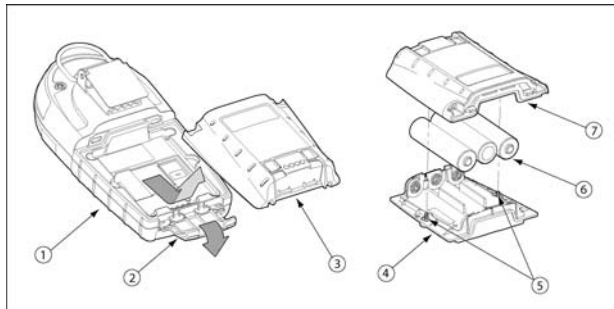

Figure 4. Replacing the Batteries

Replacing a Sensor or Sensor Filter

⚠ Warning

To avoid personal injury, use only sensors specifically designed for the detector. See the section Replacement Parts and Accessories.

Each sensor has a high degree of resistance to common vapors and gases. A sensor will most likely clear itself if you move the detector to a clean environment and wait 10 to 30 minutes. Do not expose a sensor to the vapors of inorganic solvents, such as paint fumes or organic solvents. The Troubleshooting section describes problems caused by a sensor in need of calibration or replacement.

To replace a sensor or sensor filter, refer to the following figure, table, and set of instructions.

1. If the detector is on, turn it off.
2. Remove the two machine screws on the rear shell and remove the sensor cover (or optional pump module).
3. Replace the sensor filter or replace the sensor(s). Gently rocking the sensor back and forth may help free a tightly held sensor.
4. Insert a new sensor, ensuring that sensor posts are aligned correctly.

Note

Detectors that are configured for 1, 2, 3, or 4 gases may contain a dummy sensor in one of the four sensor locations.

5. Re-assemble the detector.

Calibrate the detector after changing any sensor(s). See the section, Calibration and Setting Alarm Setpoints.

Table 13. Replacing a Sensor or Sensor Filter

| Item | Description |
|------|--------------------|
| ① | Sensor cover |
| ② | Sensor filter |
| ③ | Sensors |
| ④ | Detector |
| ⑤ | Machine screws (2) |

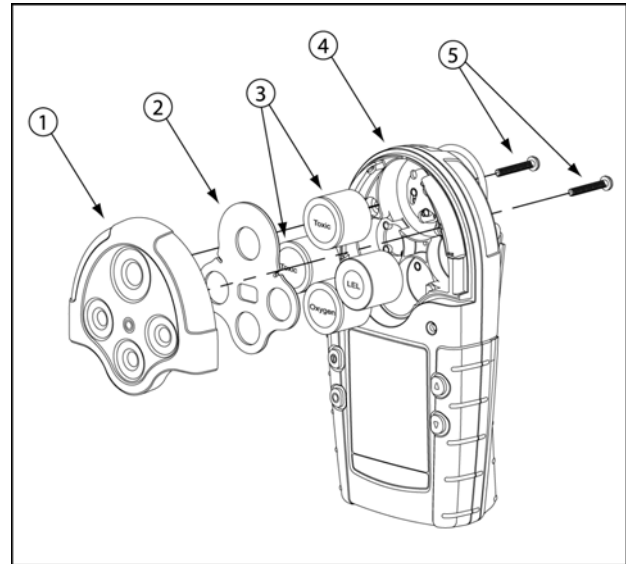

Figure 5. Replacing a Sensor or Sensor Filter

Photoionization Detector (PID)

Parts of the PID

Table 14. Parts of the PID sensor

| Item | Description |
|-------------|--------------------|
| ① | Sensor cover |
| ② | Electrode stack |
| ③ | Diffusion barrier |
| ④ | Lamp |
| ⑤ | PID sensor |

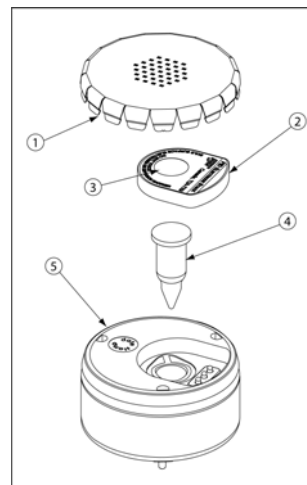

Figure 6. Parts of the PID

Clean the Lamp

⚠ Caution

Never handle the lamp with your bare hands.

The PID lamp needs to be cleaned on a regular basis (with a cleaning kit). To clean the PID lamp refer to Figure 6, Table 14, and the following set of instructions.

1. Place finger covers on your fingers.
2. Take apart the sensor to remove the lamp.
3. Place some methanol on the end of a cotton-tipped stick before using it to clean the lamp.
4. Once clean, reassemble the sensor.

Replace the Electrode Stack

Replace the electrode stack when it is contaminated. To replace the electrode stack, refer to Figure 6, Table 14, and the following set of instructions.

1. Remove the sensor cover.
2. Remove the old electrode stack.
3. Install the new electrode stack in its place.

Note

Ensure your fingers do not make contact with the diffusion barrier and the electrodes on the underside of the stack.

4. Replace the sensor cover.

Replace the Lamp

Replace the lamp when it falls below the acceptable level. To replace the lamp refer to Figure 6, Table 14, and the following set of instructions.

1. Remove the old lamp from the PID.
2. Ensure finger covers are on before inserting the new lamp into the PID shell.
3. Reassemble the sensor.

Installing the MMC/SD Card

The following figure and set of instructions illustrate how to install the MultiMediaCard (MMC)/secure digital (SD) card.

1. If the detector is on, turn off the detector.
2. Remove the battery pack (see Figure 3).
3. Slide the MMC/SD face down (pins facing down) into the MMC/SD port.
4. Replace the battery pack and secure the latch.

Table 15. Installing the MMC/SD Card

| Item | Description |
|-------------|--------------------|
| ① | Back of detector |
| ② | Battery pack |
| ③ | MMC/SD card |

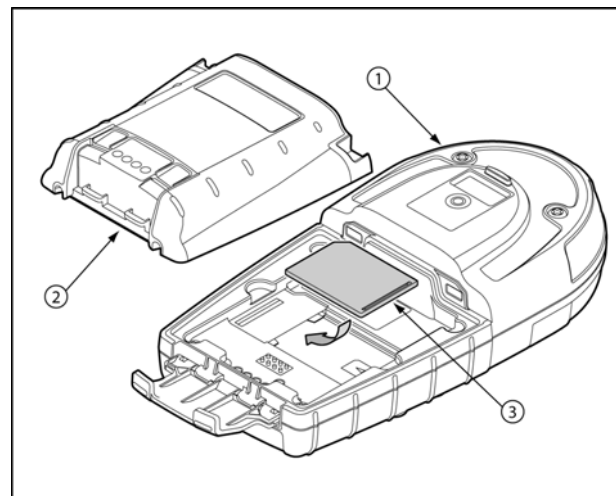

Figure 7. Installing the MMC/SD

Troubleshooting



If you are still unable to correct the problem, contact BW Technologies.

The detector's electronics are protected from variations in humidity and corrosive atmospheres. If you encounter a problem, try the solutions listed in the following table.

Table 16. Troubleshooting Tips

| Problem | Possible Cause | Solution |
|--|--|--|
| The detector does not turn on. | <ul style="list-style-type: none"> → No batteries → Depleted batteries → Damaged or defective detector | <ul style="list-style-type: none"> → Install batteries (see the section, Installing the Batteries) → Replace batteries (see the section Replacing the Batteries) → Contact BW Technologies |
| The detector enters alarm mode immediately when turned on. | <ul style="list-style-type: none"> → Sensor needs to stabilize → Low battery alarm → Sensor alarm → Pump alarm | <ul style="list-style-type: none"> → Used sensor: wait 60 seconds New sensor: wait 5 minutes → Replace batteries (see the section, Replacing the Batteries) → Replace sensor (see the section, Replacing a Sensor or Sensor Filter) → If the sampling hose is attached, determine if it is obstructed. If it is not, clean or replace the pump filter. If this does not work, see page 30 or contact BW. |
| The activation self-test fails | <ul style="list-style-type: none"> → General fault | <ul style="list-style-type: none"> → Contact BW Technologies |

Table 16. Troubleshooting Tips (cont.)

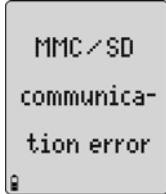
| Problem | Possible Cause | Solution |
|---|---|--|
| <p>The detector displays:</p>  | <p>→ The MMC/SD card is not inserted</p> | <p>→ Insert the MMC/SD card (refer to the Installing the MMC/SD Card section).</p> |
| <p>The detector displays:</p>  | <p>→ The MMC/SD card that is inserted in the detector has a storage size which is not supported by the detector</p> | <p>→ Insert an MMC/SD card which is 32, 64, 128, or 256 MB in size</p> |
| <p>The detector displays:</p>  | <p>→ The detector has lost communication with the MMC/SD card</p> | <p>→ Contact BW Technologies</p> |

GasAlertMicro 5

User Manual

| | | |
|--|---|---|
| The detector displays: Clock error: using last known time | → General fault | → Contact BW Technologies |
| Detector does not display normal ambient gas reading after activation self-test. | → Sensor not stabilized → Detector requires calibration → Target gas is present | → Used sensor: wait 60 seconds New sensor: wait 5 minutes → Calibrate detector (see the section, Calibration and Setting Alarm Setpoints) → Detector is operating properly. Use caution in suspect areas. |
| Detector does not respond to pushbuttons. | → Batteries are depleted → Detector is performing operations that do not require user input | → Replace batteries (see the section, Replacing the Batteries) → Pushbutton operation restored automatically when the operation ends |
| Detector does not accurately measure gas. | → Detector requires calibration → Detector is colder/hotter than ambient gas → Sensor filter is blocked | → Calibrate sensor (see the section, Calibration and Setting Alarm Setpoints) → Allow the detector to acquire ambient temperature before use → Clean the sensor filter (see the section, Replacing a Sensor or Sensor Filter) |

Table 16. Troubleshooting Tips (cont.)

| Problem | Possible Cause | Solution |
|---|---|--|
| Detector does not enter alarm. | <ul style="list-style-type: none"> → Alarm setpoint(s) are set incorrectly → Alarm setpoint(s) set to zero → Detector is in calibration mode | <ul style="list-style-type: none"> → Reset alarm setpoints (see the section, Calibration and Setting Alarm Setpoints) → Reset alarm setpoints (see the section, Calibration and Setting Alarm Setpoints) → Complete the calibration procedure |
| Detector intermittently enters alarm without apparent reason. | <ul style="list-style-type: none"> → Ambient gas levels are near alarm setpoint or the sensor is exposed to a puff of the target gas → Alarms set incorrectly → Missing or faulty sensor | <ul style="list-style-type: none"> → Detector is operating normally. Use caution in suspect areas. Check maximum gas exposure reading. → Reset alarm setpoints (see the section, Calibration and Setting Alarm Setpoints) → Replace sensor (see the section, Replacing a Sensor or Sensor Filter) |
| Detector automatically shuts off. | <ul style="list-style-type: none"> → Automatic shutdown feature activated due to weak batteries | <ul style="list-style-type: none"> → Replace batteries (see the section, Replacing the Batteries) |

Replacement Parts and Accessories

⚠ Warning

To avoid personal injury or damage to the detector, use only the specified replacement parts.

To order parts or accessories listed in Table 17, contact BW Technologies.

Table 17. Replacement Parts and Accessories

| Model No. | Description | Qty |
|-----------|---|-----|
| S4-W04 | Replacement combustible sensor | 1 |
| S4-W04-SF | Replacement combustible sensor (with silicone filter) | 1 |
| SR-X10 | Replacement O ₂ (2 year) sensor | 1 |
| PS-RM04 | Replacement CO sensor | 1 |
| PS-RH04S | Replacement H ₂ S sensor | 1 |
| SR-P04 | Replacement PH ₃ sensor | 1 |
| PS-RS04 | Replacement SO ₂ sensor | 1 |
| PS-RC10 | Replacement Cl ₂ sensor | 1 |
| SR-A04 | Replacement NH ₃ sensor | 1 |
| PS-RD04 | Replacement NO ₂ sensor | 1 |
| PS-RZ10 | Replacement HCN sensor | 1 |
| SR-V04 | Replacement ClO ₂ sensor | 1 |

| Model No. | Description | Qty |
|--------------|---|-----|
| SR-G04 | Replacement O ₃ sensor | 1 |
| D4-RHM04 | Replacement TwinTox H ₂ S/CO sensor | 1 |
| SR-PID32 | Replacement PID sensor | 1 |
| RL-PID10.6-1 | Replacement lamp for PID sensor | 1 |
| PID32-ES-1 | Replacement electrode stack for PID sensor | 1 |
| CG-Q58-4 | Quad calibration gas, CH ₄ -2.5%, O ₂ -18.0%, H ₂ S-25 ppm, CO-100 ppm, bal. N ₂ (58 l) | 1 |
| CG-Q34-4 | Quad calibration gas, CH ₄ -2.5%, O ₂ -18.0%, H ₂ S-25 ppm, CO-100 ppm, bal. N ₂ (34 l) | 1 |
| CG-T34 | Two gas calibration cylinder, 50% LEL (CH ₄ -2.5%) O ₂ -20.9%, bal. N ₂ (34 l) | 1 |
| CG-S25 | Calibration gas, SO ₂ 25 ppm (58 l) | 1 |
| CG-BUMP-S25 | SO ₂ bump test gas | 1 |
| CG-BUMP1 | Bump alarm gas aerosol (CH ₄ -2.5%, O ₂ -10%, H ₂ S-40 ppm, CO-200 ppm) | 1 |
| REG-0.5 | Regulator (0.5 l/min) | 1 |
| G0042-H25 | Calibration gas, H ₂ S 25 ppm (58 l) | 1 |
| CG2-M-200- | Calibration gas, CO 200 ppm | 1 |

| Model No. | Description | Qty |
|-------------|---|-----|
| 103 | (103 l) | |
| CG2-S-25 | Calibration gas, SO ₂ 25 ppm (58 l) | 1 |
| CG2-C-5 | Calibration gas, Cl ₂ 5 ppm (58 l) | 1 |
| CG2-Z-10 | Calibration gas, HCN 10 ppm (58 l) | 1 |
| CG2-D-10 | Calibration gas, NO ₂ 10 ppm (58 l) | 1 |
| CG2-P-1-58 | Calibration gas, PH ₃ 1 ppm (58 l) | 1 |
| CK-Q34-4 | Quad calibration kit with regulator, quad gas cylinder (CG-Q34-4), hose and carrying case | 1 |
| CK-Q58-4 | Quad calibration kit with regulator, quad gas cylinder (CG-Q58-4), hose and carrying case | 1 |
| CR-MMC-USB1 | MMC USB reader (USB port) with software for user-downloadable datalogger | 1 |
| MMC32 | 32 MB MultiMediaCard | 1 |
| MMC64 | 64 MB MultiMediaCard | 1 |
| MMC128 | 128 MB MultiMediaCard | 1 |
| M5-BAT01 | Rechargeable battery pack | 1 |
| M5-BAT02 | Alkaline battery pack | |
| GAMIC-BAT-K | Rechargeable AA NiMH batteries, 1800 mAh, kit of 4 (not applicable for Europe) | 1 |

| Model No. | Description | Qty |
|---------------|--|-----|
| GAMIC-BAT-K2 | Rechargeable AA NiMH batteries, 1600 mAh, kit of 4 | 1 |
| M5-CO1* | GasAlertMicro 5 battery charger | 1 |
| M5-CO1-BAT01* | GasAlertMicro 5 battery charger and battery pack kit | |
| GA-CH-2 | Chest harness | 1 |
| GA-ES-1 | Extension strap | 1 |
| | Calibration cap (standard) | 1 |
| GAMIC-AG2 | Alligator clip (stainless steel) | 1 |
| D4-AS01 | Manual aspirator pump with 10 ft./3 m hose | 1 |
| GA-AS02 | Manual aspirator pump with 1 ft./0.3 m probe | 1 |
| GA-TPROB6 | Telescopic sample probe (6.5 ft./2 m) | 1 |

**Add suffix (-UK) for United Kingdom mains plug, (-EU) for European mains plug, (-AU) for Australian mains plug.*

Specifications

Instrument dimensions: 14.5 x 7.4 x 3.8 cm
(5.7 x 2.9 x 1.5 in.)

Weight: 300 g (10.6 oz.)

Operating and Storage Conditions:

Temperature:

VOC: -10°C to +40°C (-14°F to +104°F)

Other gases: -20°C to +50°C (-4°F to +122°F)

Humidity:

O₂: 0% to 99% relative humidity (non-condensing)

VOC: 0% to 95% relative humidity (non-condensing)

Combustibles: 5% to 95% relative humidity
(non-condensing)

Cl₂: 10% to 95% relative humidity (non-condensing)

HCN, ClO₂: 15% to 95% relative humidity (non-condensing)

Other gases: 15% to 90% relative humidity
(non-condensing)

Pressure:

95 to 110 kPa

Alarm setpoints: May vary by region and are user-settable.

Detection range:

O₂: 0 – 30.0% vol. (0.1% vol. increments)

CO: 0 – 999 ppm (1 ppm increments)

H₂S: 0 – 100 ppm (1 ppm increments)

Combustibles: 0 – 100% LEL (1% LEL increments) or
0 – 5.0% v/v methane

PH₃: 0 – 5.0 ppm (0.1 ppm increments)

SO₂: 0 – 100 ppm (1 ppm increments)

Cl₂: 0 – 50.0 ppm (0.1 ppm increments)

NH₃: 0 – 100 ppm (1 ppm increments)

NO₂: 0 – 99.9 ppm (0.1 ppm increments)

HCN: 0 – 30.0 ppm (0.1 ppm increments)

ClO₂: 0 – 1.00 ppm (0.01 ppm increments)

O₃: 0 – 1.00 ppm (0.01 ppm increments)

VOC: 0 – 1000 ppm (1.0 ppm increments)

Sensor type:

H₂S/CO: Twin plug-in electrochemical cell

Combustibles: Plug-in catalytic bead

VOC: Photoionization detector (PID)

Other gases: Single plug-in electrochemical cell

O₂ measuring principle: Capillary controlled concentration sensor

Pump flow rate: 250 ml/min. (minimum)

Alarm conditions: TWA alarm, STEL alarm, low alarm, high alarm, multi-gas alarm, sensor alarm, pump alarm, low battery alarm, confidence beep, automatic shutdown alarm

Audible alarm: 95 dB at 1 ft. (0.3 m) variable pulsed dual beepers

Visual alarm: Dual red light-emitting diodes (LED)

Display: Alphanumeric liquid crystal display (LCD)

Backlight: Automatically activates whenever there is insufficient light to view the display (if enabled) and during alarm conditions.

Self-test: Initiated upon activation

Calibration: Automatic zero and automatic span

Oxygen sensor: Automatic span upon activation (selectable)

User field options: Confidence beep, latching low and high alarms, pass code protection, enable/disable safe display mode, combustible sensor measurement, sensor disable, set calibration due date, TWA and STEL, stealth mode, language selection, enable/disable automatic oxygen calibration, set span concentration values, set STEL calculation period, set TWA method, enable/disable automatic backlight, adjust clock calendar, and set logging rate (datalogger models only).

Battery operating time:

Given that the detector is operating with an LEL and PID sensor and the optional BW M5 pump module:

3 alkaline cells: 8-10 hours

1 rechargeable NiMH pack: 14-16 hours

Approved batteries:

North America

Approved batteries for product (standards IEC 60279-11, EN50020, UL913, C22.2 No. 157)

Alkaline:

Duracell MN1500 -20°C ≤Ta ≤ +50°C

-20°C ≤Ta ≤ +40°C

Energizer E91 -20°C ≤Ta ≤ +50°C

-20°C ≤Ta ≤ +40°C

Temperature Code

NiMH rechargeable:

M5-BAT01

-20°C ≤Ta ≤ +50°C

T4

Battery charger: GasAlertMicro 5 battery charger

First-time charge: 4 hours per battery pack

Normal charge: 3-4 hours per battery pack

This equipment has been tested and found to comply with the limits for a Class B digital device, pursuant to Part 15 of the FCC Rules and ICES-003 Canadian EMI requirements. These limits are designed to provide reasonable protection against harmful interference in a residential installation. This equipment generates, uses and can radiate radio frequency energy and, if not installed and used in accordance with the instructions, may cause harmful interference to radio communications. However, there is no guarantee that interference will not occur in a particular installation. If this equipment does cause harmful interference to radio or television reception, which can be determined by turning the equipment off and on, the user is encouraged to try to correct the interference by one of more of the following measures:

- Reorient or relocate the receiving antenna.
- Increase the separation between the equipment and receiver.
- Connect the equipment into an outlet on a circuit different from that to which the receiver is connected.
- Consult the dealer or an experienced radio/TV technician for help.

General Specifications for Datalogger Units

Media Type: MultiMediaCard (MMC)

Size: 32 MB (standard); (64, 128, and 256 MB card available)

Storage: 500,000 lines of data available; 4.4 months at 5 second intervals (based on a normal work week)

Memory type: Wraparound memory ensures most recent data is always saved

Sample rate: One reading every 5 seconds (standard)

Data recorded: All sensor readings, all alarm conditions, calibrations, event flags, battery status, pump status, sensor status, confidence beep activation, and detector status along with the time and date for each reading and unit serial number

MMC card test: Automatically on activation

GasAlertMicro 5 with User Downloadable Datalogger

Operation: Requires no user intervention (automatic)

Indicators: Icon advises datalogger is operating normally, MMC card missing/malfunction advise

Compatible with: Desktop PC computer or laptop

Operating system: Windows 95 or higher; Macintosh OS 8.6 or higher

Download via: MMC/SD card reader.

Software required: Spreadsheet or database compatible with comma-separated-value (CSV) text files (Excel, Access, Quattro, etc.)

Card alarm: Card fail or missing

Support:

Fleet Manager: Fleet Manager is an Access software add-in that enhances the abilities of Microsoft® Access when handling GasAlertMicro 5 user downloadable datalogger data files.



D5615 English

iERP: 115695

© 2005 BW Technologies. All rights reserved. Printed in Canada.

All product names are trademarks of their respective companies.

